

# SERVER W / NAVIGATOR

SPARE PARTS









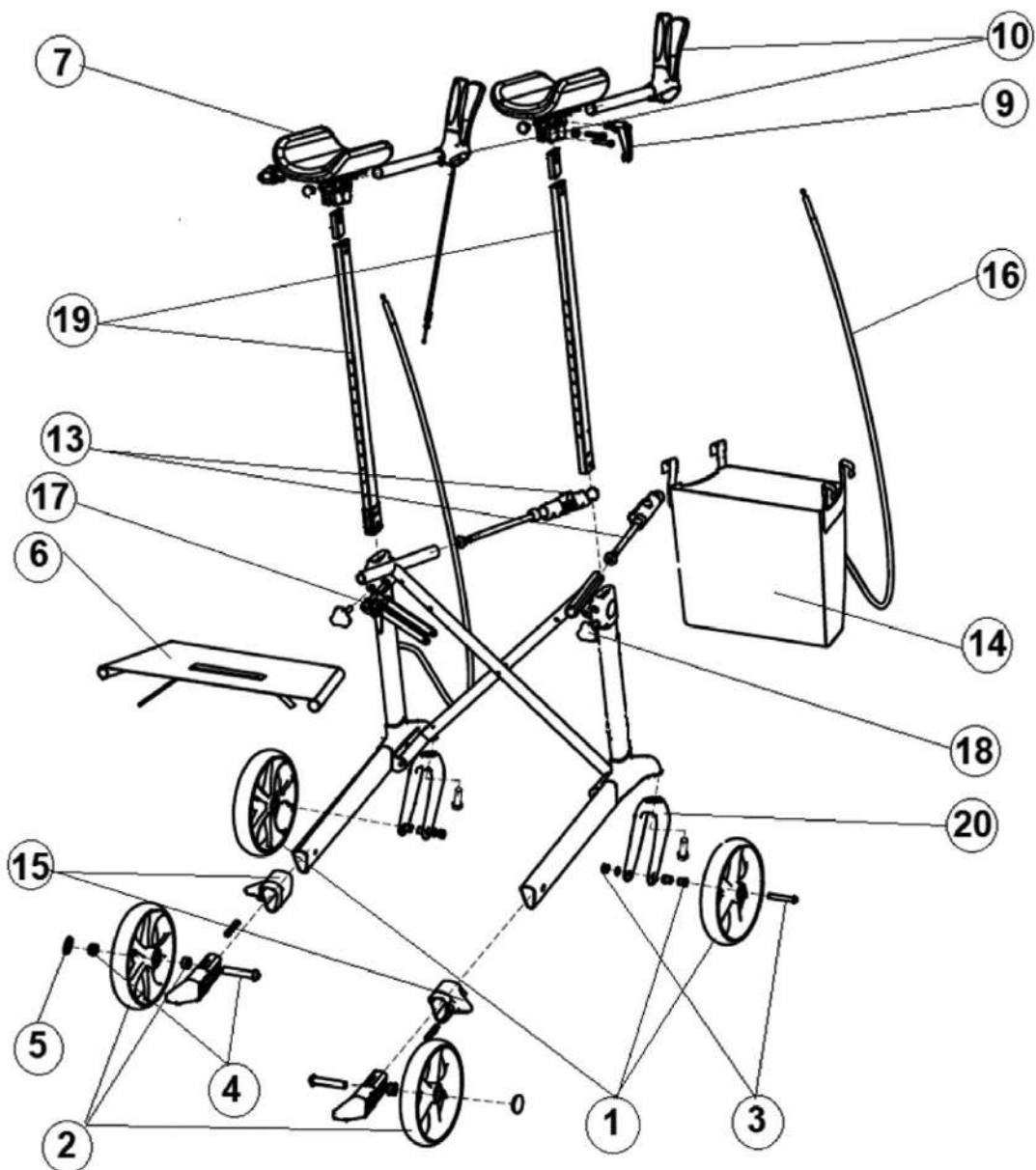







Pricelist is valid from 1.01.2025 until the new one is published.

Please send orders by email to the following address: [ukadmin@rehasense.com](mailto:ukadmin@rehasense.com)

# TECHNICAL DRAWING FOR SERVER W / NAVIGATOR



No.	Picture	Item description	Item no	RRP included
1A		Front wheel set, <b>silver rim</b> with standard <b>TPE tyre</b> and distance bushings (set of 2 pcs)	ROL30H-RS	
2A		Rear wheel set, <b>silver rim</b> with standard <b>TPE tyre</b> and distance bushings (set of 2 pcs)	ROL30J-RS	
1B		Front wheel set, <b>silver rim</b> with soft <b>PU tyre</b> and distance bushings (set of 2 pcs)	ACR1016FSB	
2B		Rear wheel set, <b>silver rim</b> with soft <b>PU tyre</b> and distance bushings (set of 2 pcs)	ACR1016RSB	
3		Fitting set for mounting of front wheels - 2 pcs, (incl. m8 bolts, washers and lock nuts)	1910H7-RS	
4		Fitting set for mounting of rear wheels - 2 pcs (incl. m12 bolts, 9 mm distance bushings, lock nuts and 2x caps)	1910CX-RS	
5		Cap for axle hole on the rear wheels, black rubber	641005	
6		Seat incl. strap (46 cm), black nylon	ROL10F-RS	
7		Black <b>PU</b> arm support (fits both sides)	ROL167-RS	
8		Screw m6 x 20 mm with countersunk head, galvanized steel - for fixing arm supports	19200Y	
9		Black clamping lever, m8 x 27 mm	67101K	
10		Driving handle assembling, 1set - for Navigator	ROL408-RS	
11		Complete steel shafts incl. a+lock for seat tubes - set of 2 pcs, left and right	ROL20A-RS	
12		Standard net bag for <b>large</b> and <b>medium</b> Server rollators, black with reflectors	ROL1AA-RS	

No.	Picture	Item description	Item no	RRP included
13		Brake block, set of 2 pcs (left + right)	ROL1DR-RS	
14		Brake cable for <b>large</b> Server rollator incl. brake adjuster (1 pcs)	69100X-RS	
		Brake cable for <b>medium</b> and <b>small</b> Server rollator incl. brake adjuster (1 pcs)	69100Z-RS	
15		Complete locking mechanism for <b>large</b> size	ROL1DW-RS	
		Complete locking mechanism for <b>medium</b> size	ROL1DX-RS	
16		Finger screw for height adjustment	ROL125	
17		Inner tube for right push handle on <b>large</b> Server rollator	ROL27C-RS	
		Inner tube for right push handle on <b>medium</b> Server rollator	ROL27CM-RS	
18		Inner tube for left push handle on <b>large</b> Server rollator	ROL295-RS	
		Inner tube for left push handle on <b>medium</b> Server rollator	ROL295M-RS	
19		Front fork, black (1 pcs)	ROL11Z-RS	
		Connecting belt set (L+R), for Navigator	ROL16N-RS	

**NOTE:** We do not offer cross and side frames as spare parts. With good reason we classify such damages as dangerous and total loss. It means the user needs a new rollator. Safety is the highest priority.



# REHASENSE

**REHASENSE UK**  
**UNIT 5, GUILFORD ROAD**  
**INDUSTRIAL ESTATE**  
**HAYLE, CORNWALL, TR27 4BA**  
**UNITED KINGDOM**  
☎ **+44 (0) 333 220 0704**  
✉ **UKADMIN@REHASENSE.COM**

REHASENSE ITALY SRL  
VIALE DELLE INDUSTRIE 5  
20044 ARESE (MI) ITALY  
☎ +39.02.99 77 08  
✉ INFO.ITALY@REHASENSE.COM

REHASENSE DEUTSCHLAND GMBH  
STERNBERGER STRASSE 12,  
32699 EXTERTAL,  
GERMANY  
☎ +49 2821 590 8587  
✉ INFO@REHASENSE.COM

REHASENSE DENMARK  
GLARMESTERVEJ 16 A, ST. TV.  
8600 SILKEBORG,  
DENMARK  
☎ +49 176 588 788 01  
✉ INFO@REHASENSE.COM

REHASENSE SP. Z O.O.  
SULEJOWSKA 45G  
97-300 PIOTRKÓW TRYBUNALSKI  
POLAND  
☎ +48 880 331 272  
✉ INFO@REHASENSE.COM

REHASENSE BENELUX  
MARKEWEG 81  
8398GM BLESIJKE,  
NETHERLANDS  
☎ +31 653 837 211  
✉ INFO@REHASENSE.NL

REHASENSE SVERIGE AB  
POLHEMSGATAN 28, SE-392 39 KALMAR  
SWEDEN  
☎ +46 722 325 090  
✉ MATS.LAVEBORN@REHASENSE.COM

REHASENSE CHINA  
NO.289, WENGJIAO ROAD  
XINYANG INDUSTRIAL AREA  
361022 HAICANG, XIAMEN,  
CHINA  
☎ +86 592 688 4014  
✉ EVELYN.CHEN@REHASENSE.COM

REHASENSE KOREA  
1F. 338-46, DONGBUSUNHWAN-RO,  
WONJU-SI 26454 GANGWON-DO,  
REPUBLIC OF KOREA  
☎ +82 070 4216 3429  
✉ JONGSUNG.KIM@REHASENSE.COM

REHASENSE NEW ZEALAND  
UNIT 4, 260 APIRANA AVENUE  
GLEN INNES, AUCKLAND, 1072,  
NEW ZEALAND  
☎ +09 555 3111  
✉ NZ-INFO@REHASENSE.COM

REHASENSE MOBILITY CANADA LTD  
137 BUTTERMILL AVENUE  
CONCORD, ONTARIO, L4K 3X5  
CANADA  
☎ +1 289 654 1901  
✉ INFO.CANADA@REHASENSE.COM

REHASENSE USA  
1333 BURR RIDGE PARKWAY, SUITE 200  
BURR RIDGE, IL 60527,  
USA  
☎ +1 630 756 3099  
✉ INFO-USA@REHASENSE.COM

REHASENSE MENA  
QETAF MEDICAL EST  
3599 PRINCE MOHAMMED BIN  
ABDULAZIZ ST,  
SAUD LANGAWI CENTER, AL ANDALUS  
JEDDAH 23326,  
SAUDI ARABIA  
☎ +96 650 664 1993  
✉ SALES-MIDDLE-EAST@REHASENSE.COM

REHASENSE COLOMBIA  
CALLE 171 # 21 A 47  
BARRIO LA URIBE, BOGOTÁ  
COLOMBIA  
☎ +57 3153118652  
✉ IVANUMANA@REHASENSECOLOMBIA.COM

REHASENSE AUSTRALIA PTY LTD  
☎ +61 475 856 207  
✉ WERNER.PETZER@REHASENSE.COM



Rehasense's quality management complies with both the ISO 9001 and ISO 13485 standards, as confirmed by TÜV NORD. Rehasense's medical devices are CE-marked and meet the requirements of EU Regulation 2017/745 (MDR).  
Copyright Rehasense® 2025



VI-2025